

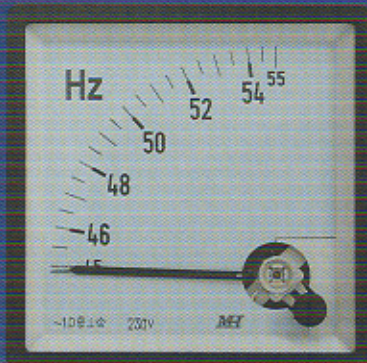

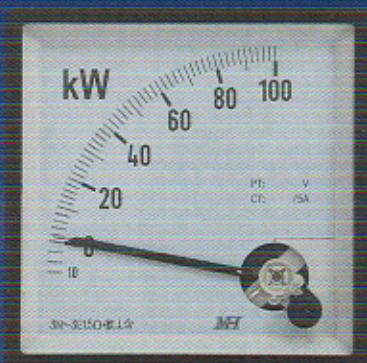

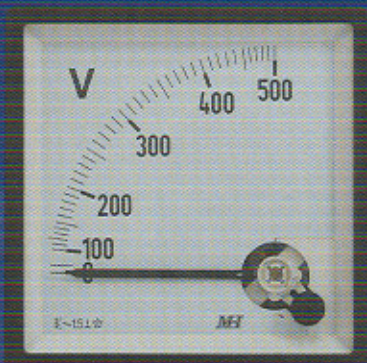

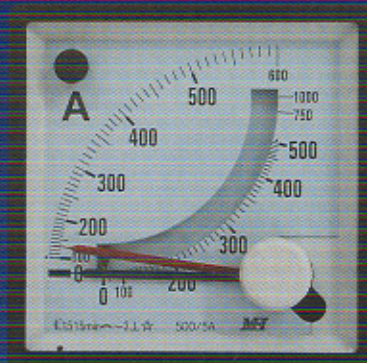

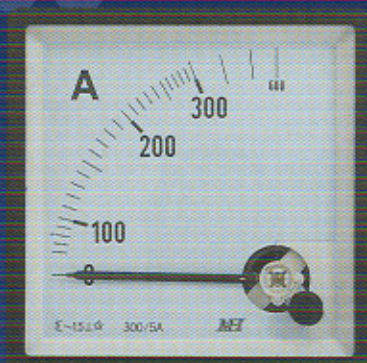

MH series

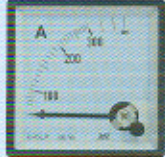
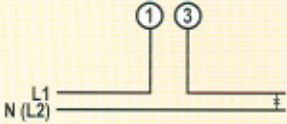

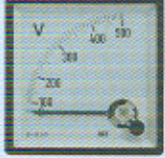
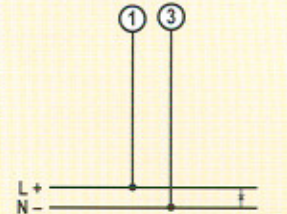
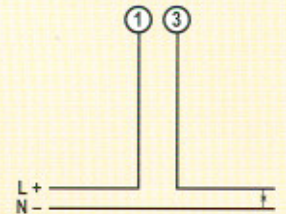

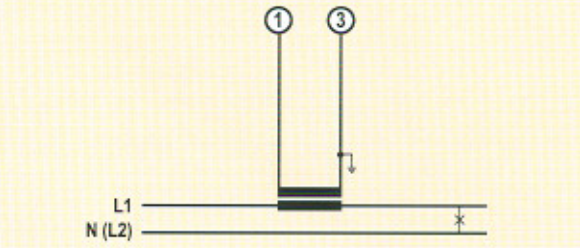

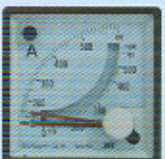
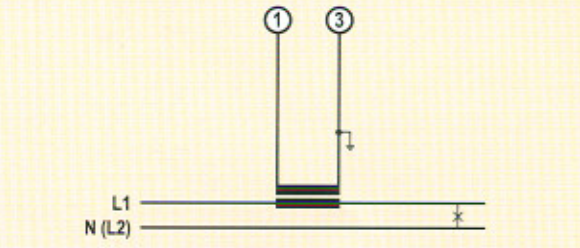

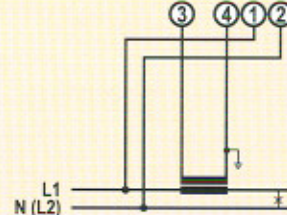
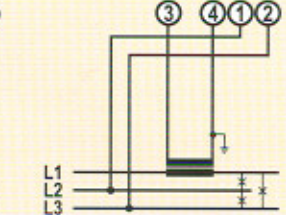
for Quality and Accuracy

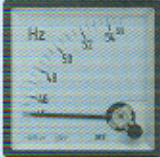
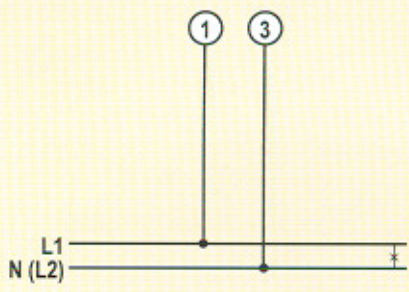
*Square Range of
Measuring Instruments*

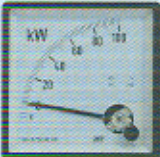
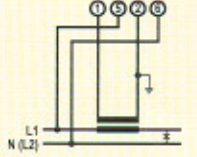
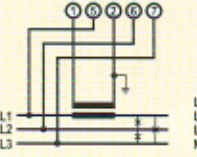
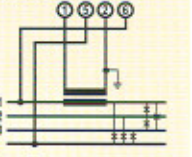
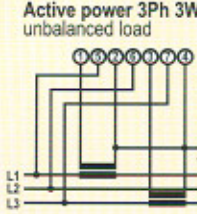
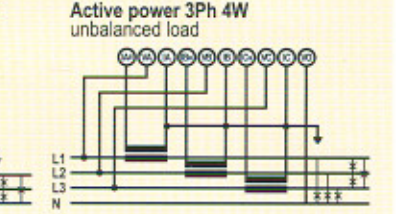

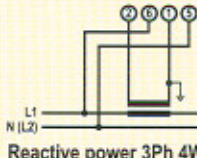
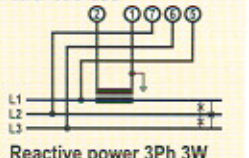
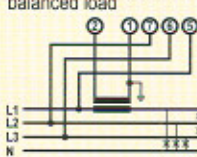
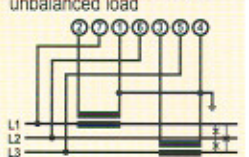
**IEC 51
BS 89
ISO 9001:2000 CE**

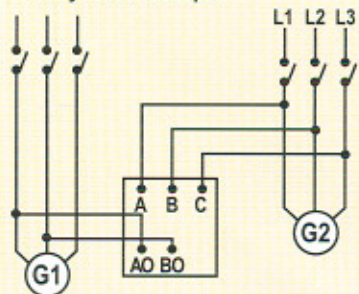
	TYPE	RANGE	CONNECTION DIAGRAM
MOVING IRON  	AC Ammeter CP-96A CP-72A CP-48A	Direct: 0.1, 0.5, 1, 1.5, 3, 5, 10, 15, 20, 25, 30, 50, 60, 100A * CP-48 max. 50A .../5A .../1A	AC current direct connection  AC current transformer connection 
	AC Voltmeter CP-96V CP-72V CP-48V	30, 50, 75, 100, 120, 150, 200, 250, 300, 400, 500, 600V	
MOVING COIL  	DC Ammeter CP-96DA CP-72DA CP-48DA	Direct: 100, 150, 200, 300, 500µA 1, 3, 7.5, 10, 15, 20, 30, 50, 75, 100, 150, 200, 250, 300, 450, 500mA, 4-20mA, 1, 3, 5, 7.5, 10, 15, 20, 30, 50A	DC Voltage  DC Current 
	DC Voltmeter CP-96DV CP-72DV CP-48DV	3, 5, 7.5, 10, 15, 20, 30, 50, 75, 100, 150, 200, 250, 300, 450, 500, 600V 60mV, 100mV, 150mV	
MAXIMUM DEMAND INDICATOR  	Maximum Demand Meter (2 pointer) CP-96MD2 CP-72MD2	15 min ./5A 8, 20 & 30 minutes are optional Thermal 20%	Current transformer operated 
MOVING IRON + MDI  	Combined Maximum Demand Meter (3 pointer) CP-96MD3 CP-72MD3	15 min ./5A 8 & 30 minutes are optional Thermal 20% Inst 100%	Current transformer operated 
POWER FACTOR  	Power Factor Meter Single & Three Phase CP-96PF CP-72PF	0.5cap-1-0.5 ind .../5A L-L AC220V, 389V L-L AC415V, 440V	Power factor 1Ph AC  Power factor 3Ph AC 
Accuracy: class 1.5			
Accuracy: class 1.5			
Accuracy: class 3			
Accuracy: class 3			
Accuracy: class 3 (± 2 electrical degree)			

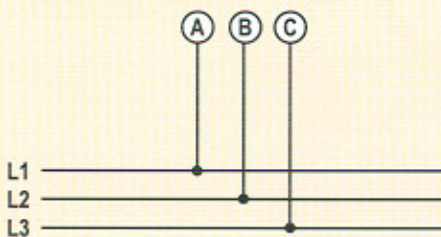
	TYPE	RANGE	CONNECTION DIAGRAM		
FREQUENCY METER   Accuracy: class 0.5	Frequency Meter (Pointer Type) CP-96FQP CP-72FQP CP-48FQP	45~55Hz 55~65Hz 45~65Hz Input Voltage: 110V, 220V 380 - 440V	Frequency 1Ph / 3Ph AC 		
	Frequency Meter (Reed Type) CP-96FQR CP-72FQR	7 Reed 47~53Hz 57~63Hz 11 Reed 45~55Hz 55~65Hz Input Voltage: 110V, 220V 380 - 440V			
WATTMETER   Dimension: CP 96# Accuracy: class 1.5	Wattmeter (Balanced) Single phase Three phase 3 wire Three phase 4 wire CP-96WB CP-72WB	Input voltage: 120V, 220V, 240V, 380V, 415V, 440V Input Amp: 5A	Active power 1Ph AC 	Active power 3Ph 3W balanced load 	Active power 3Ph 4W balanced load 
	Wattmeter (Unbalanced) Single phase Three phase 3 wire Three phase 4 wire CP-96WU CP-72WU		Active power 3Ph 3W unbalanced load 	Active power 3Ph 4W unbalanced load 	
VARMETER   Dimension: CP 96# Accuracy: class 1.5	Varmeter (Balanced) Single phase Three phase 3 wire Three phase 4 wire CP-96VRB CP-72VRB	Input voltage: 120V, 220V, 240V, 380V, 415V, 440V Input Amp: 5A	Reactive power 1Ph AC 	Reactive power 3Ph 3W balanced load 	
	Varmeter (Unbalanced) Single phase Three phase 3 wire CP-96VRU CP-72VRU		Reactive power 3Ph 4W balanced load 	Reactive power 3Ph 3W unbalanced load 	
SYNCHRONOSCOPE   Accuracy: ±2 electrical degrees	Synchronoscope Meter CP-96SC CP-72SC	Input voltage: 110V, 220V, 380V, 500V Input Amp: 5A	3Ph Synchronoscope 		
PHASE SEQUENCE  	Phase-Sequence Meter CP-96PS CP-72PS	Input voltage: 150V - 500V AC	3Ph Sequence indicator 		

The MH Series Switchboard measuring instruments offer a comprehensive range to meet most requirements. These are manufactured to comply with International Standard to ensure that high and reliable qualities are met. These are also constructed to withstand severe vibration.

MH Series meters are suitable for horizontal and vertical in-line mounting. These meters are easy to install and space-saving. Furthermore, the interchangeable scales enable meters to be widely used and speed up delivery.

PANEL CUT-OUTS (All dimensions mm)

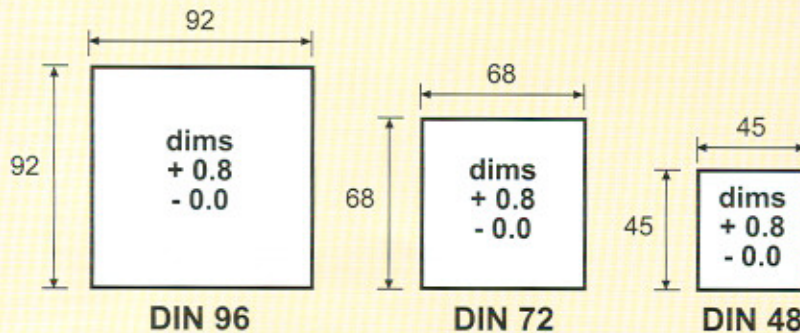

DIN 48 can be slot mounted using the standard fixing clip.
DIN 72 & DIN 96 can be supplied with special fixing clips for slot mounting.

TECHNICAL SPECIFICATIONS

Standards:
EN60051, IEC51, BS89, DIN 43780

Enclosure:
DIN 43700
Material: Acrylonitrile Butadiene Styrene (ABS) & Polycarbonate (PC)
Flame Retardant
Base material UL94VO
Case & terminal cover material UL94VO

Insulation Test:
2kV / 1 min

Temperature:
-10°C to +50°C

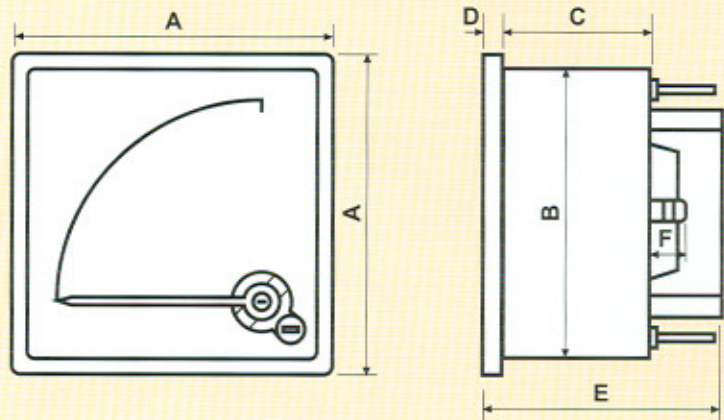

MODEL	A	B	C	D	E	F
CP96	96	92	44	6	70	13
CP96#	96	92	44	6	102	13
CP72	72	68	44	6	70	13
CP48	48	44	44	6	69	13

Every effort is made to ensure accuracy of information but due to our policy of continuous development, specifications should be checked at the time of ordering.
***Other type and range are also available upon request.**

Marketed by



Mun Hean Singapore Pte Ltd

51 Kim Keat Road, Unit 05-02
Mun Hean Industrial Building, Singapore 328821.
Tel: (65) 6250 0522 Fax: (65) 6253 6885 / (65) 6253 5879
E-mail: munheansing@munhean.com.sg
Website: <http://www.munheansingapore.com>

Mun Hean Electrical Engineering (HK) Co Ltd
Room 1701, 17/F Kodak House II, 321 Java Road, North Point, Hong Kong.
Tel: (852) 2873 1711 Fax: (852) 2518 7013
E-mail: munheanhk@munhean.com.hk
Website: <http://www.munheanhongkong.com>

Mun Hean (Malaysia) Sdn Bhd

15, Jalan SS 26/6, Taman Mayang Jaya,
47301 Petaling Jaya, Selangor Darul Ehsan, Malaysia.
Tel: (603) 7804 2288 Fax: (603) 7803 1185
E-mail: mhmsb@pc.jaring.my
Website: <http://www.munheanmalaysia.com>

MH Poly-Electromechs, Inc.

No. 31 Mayon St., Unit G Villa Maria
Brgy. Malamig, Mandaluyong City, Philippines.
Tel: (632) 531 5865 / (632) 531 5775 Fax: (632) 531 9086
E-mail: polyelec@pacific.net.ph